

10%  
made in Italy

Medical Line

## Lemi 4

Over 15.000 doctors in the world  
chose Lemi ergonomics and style

*Oltre 15.000 medici nel mondo  
hanno scelto ergonomia e stile Lemi*



Multifunctional couch-bed  
*Poltrona-lettino multispecialistica*

**Lemi**<sup>®</sup>  
MADE IN ITALY

# Movements / Movimentazioni

DIAGNOSTICS • CHECK-UP • DERMATOLOGY  
AESTHETIC SURGERY • MINOR SURGERY INTERVENTIONS • CHEMIST'S  
DENTAL CLINICS • GYNECOLOGIC VISITS • BLOOD SAMPLE TAKING

- 4 independent electric movements: height, back rest, leg rest, trendelenburg
- 1 synchronized electric movement: back rest/leg rest
- 1 manual movement: head rest adjustment
- Automatic reset control to bring the couch back to the initial position

Electric height  
*Altezza elettrica*  
62-92 cm  
(24"-36")



25°



Electric Trendelenburg  
*Trendelenburg elettrico*

VISITE DIAGNOSTICHE • CHECK-UP • DERMATOLOGIA  
MEDICINA ESTETICA • PICCOLA CHIRURGIA AMBULATORIALE  
FARMACIE • ODONTOIATRIA • VISITE GINECOLOGICHE • PRELIEVI

Lemi 4 • cod. 105

4 movimenti elettrici indipendenti: altezza, schiena, gambe, trendelenburg  
1 movimento elettrico sincronizzato: schiena/gambe  
1 movimento manuale: inclinazione testa  
Comando di azzeramento automatico che riporta il letto nella posizione base

Synchronized back rest/leg  
rest movement

*Movimentazione sincronizzata  
schiena/gambe*

Electric leg rest  
*Gambe elettriche*



Electric back rest  
*Schiena elettrica*

Adjustable head rest  
*Testa regolabile*



DIAGNOSTICS • CHECK-UP • DERMATOLOGY  
AESTHETIC SURGERY • MINOR SURGERY INTERVENTIONS • CHEMIST'S  
DENTAL CLINICS • GYNECOLOGIC VISITS • BLOOD SAMPLE TAKING

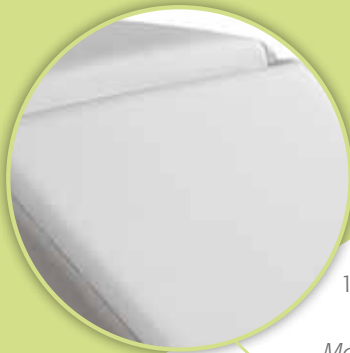

1-section flat mattress  
without stitching

*Materasso piatto senza  
cuciture realizzato in un  
unico modulo*

Predisposition for medical  
accessories to adapt the  
couch to any purpose

*Predisposizione accessori  
medicali per adattare la  
poltrona ad ogni utilizzo*

Maximum load weight  
without risk 200 kg

*Portata max in sicurezza  
200 kg*

Wide choice of upholsteries  
available on stock

*Ampia scelta di rivestimenti  
disponibili a stock*

Foot pedal control with  
automatic reset to zero

*Pulsantiera con  
azzeramento automatico*

Its complete ABS covering  
grants elegance and safety  
while protecting the inner  
components from liquids

*Completamente chiuso con  
carter in ABS garantisce  
alla poltrona eleganza e  
sicurezza, proteggendo i  
componenti interni dai liquidi*

4 adjustable small feet under the base

*4 piedini regolabili alla base*

4 electric continuously  
variable actuators 24V cc

*N° 4 motori elettrici 24 V cc  
a regolazione continua*

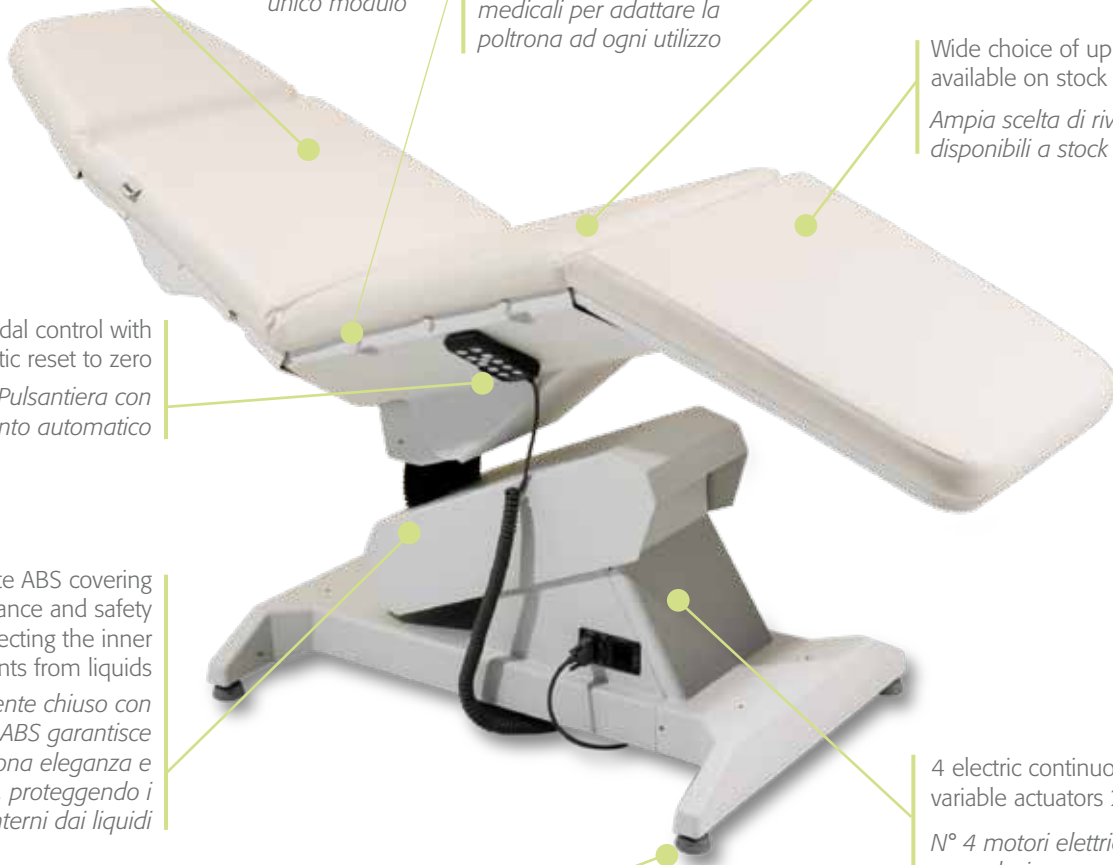

## Technical specifications

Minimum height: 62 cm - 24"

Maximum height: 92 cm - 36"

Angle of inclination trendelenburg: 25°

Angle of inclination back rest: 75°

Angle of inclination leg rest: 65°

Angle of inclination head rest: 27°

Mattress length: 190 cm - 75"

Mattress width: 62 cm - 24"

Thickness of anatomic mattress: cm 10 - 4"

Latex-free, non-toxic and non-carcinogenic materials

Fire-resistant upholstery: UNI 9175 class 1M

## Specifiche tecniche

Altezza minima: 62 cm

Altezza massima: 92 cm

Angolo inclinazione trendelenburg: 25°

Angolo inclinazione schiena: 75°

Angolo inclinazione gambe: 65°

Angolo inclinazione testa: 27°

Lunghezza materasso: 190 cm

Larghezza materasso: 62 cm

Spessore materasso anatomico: 10 cm

Materiali privi di lattice, atossici e non cancerogeni

Rivestimento ignifugo: UNI 9175 class 1M

## Electric requirements

Voltage: 230V ac, 110V ac

Frequency: 50 Hz / 60 Hz

Absorption: 0,70 A max

Electric system conforms to CEI norms

4 actuators 24V cc (thrust 6000 N)

Class II control box 220Vac 50Hz

Transformer 120 Va

Class I medical device (dir. 93/42/CEE)

Protection rating IP54

Low-tension 11- switch hand set control

## Packaging details

Size: 170x74x86h cm (67"x30"x34")

Volume: 1,081 m<sup>3</sup>

Gross weight: 89 kg - 196 lbs

Net weight: 73 kg - 161 lbs

## Caratteristiche imballo

Dimensioni: 170x74x86h cm

Volume: 1,081 m<sup>3</sup>

Peso lordo: 89 kg

Peso netto: 73 kg

## Caratteristiche elettriche

Voltaggio: 230V ac, 110V ac

Frequenza: 50 Hz

Assorbimento: 0,70 A max

Impianto elettrico a norme CEI

4 attuatori 24V cc (spinta 6000N)

Centralina in classe II 220 Vac 50Hz

Trasformatore da 120 Va

Disp. Medico classe I (dir. 93/42/CEE)

Grado di protezione IP54

Pulsantiera a 11 tasti a bassa tensione

## Warranty

Structure: 10 years

Motors and control: 2 years

Cushion: 5 years

Heating: 1 year

## Garanzia

Struttura: 10 anni

Motori e comandi: 2 anni

Imbottitura: 5 anni

Riscaldamento: 1 anno

Accessories upon request / Accessori su richiesta



cod. 108



cod. 111



cod. 111P



cod. 180 L



cod. 109



cod. 107



cod. 112 a



cod. Prot. gambe



cod. 331



cod. 319-320



cod. LEM-151



cod. LEM-139



cod. LEM-067



cod. 318



cod. 313



cod. 314



cod. 316-317

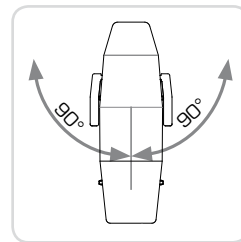

cod. ROT

**cod. 108**

roll holder/*porta rotolo*

**cod. 111**

big Zak head rest/*testa Zak grande*

**cod. 111P**

small Zak head rest/*testa Zak piccola*

**cod. 180 L**

seat and backrest heating  
*riscaldamento seduta e schiena*

**cod. 109**

anatomic mattress w/out stitching  
*materasso anatomico senza cuciture*

**cod. 107**

flat armrest couple  
*coppia braccioli automatici*

**cod. 112 a**

american head rest with face hole  
*testa americana*

**cod. Prot. gambe**

plastic cover for leg rest/*proteggi gambe*

**cod. 331**

metal tray with support/*vassoio con supporto*

**cod. 313**

medical armrest couple  
*coppia braccioli medicali*

**cod. 314**

blood-sample taking armrest  
*coppia braccioli da prelievo con snodo*

**cod. 318**

jointed thigh support couple  
*coppia reggicosce con snodo*

**cod. 319-320**

fixed and rotating clamp couple  
*coppia morsetti fissi girevoli*

**cod. LEM-151**

heel support couple/*coppia reggi tallone*

**cod. LEM-139**

wheels/*ruote*

**cod. LEM-067**

foot pedal control / *pedaliera*

**cod. 316-317**

seat and back rest medical guide couple  
*coppia guide medicali seduta e schiena*

**cod. ROT**

rotation 180° / *rotazione 180°*

## Mattress colors / *Colori materasso*

**P35**

Bianco



**B41**

Grigio

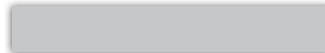

**B99**

Nero

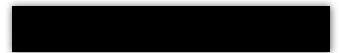

**D02**

Crema

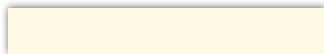

**G10**

Blu



**H98**

Viola



**G03**

Azzurro



**EB1**

Verde



**E16**

Marrone



**G85**

Cielo

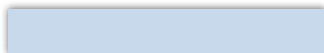

**N31**

Arancio



**Q73**

Mais



## ABS covering colors/ *Colori carter*

**105 G**

Light grey  
*Grigio*



**105 N**

Black  
*Nero*

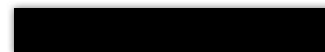

**105 B**

White  
*Bianco*



The colors above are provided only as a guide and could be subjected to a variation due to the material different from the printed paper.

*I colori sopra riportati sono indicativi e possono essere soggetti a variazioni dovute al materiale diverso dalla carta stampata.*

Product images are for illustrative purposes only.  
The manufacturer has the right to modify pictures and descriptions  
of this catalogue at any time for commercial or technical purposes.

*L'immagine ha il solo scopo illustrativo.  
Il costruttore si riserva il diritto di effettuare le modifiche  
alle immagini e alle descrizioni di questo catalogo  
in ogni momento per esigenze di carattere  
tecnico e commerciale.*

**credits:**

photo by Studio Pi-Tre



N° 443.090.V



## Table of dimensions / *Tabella dimensionale*

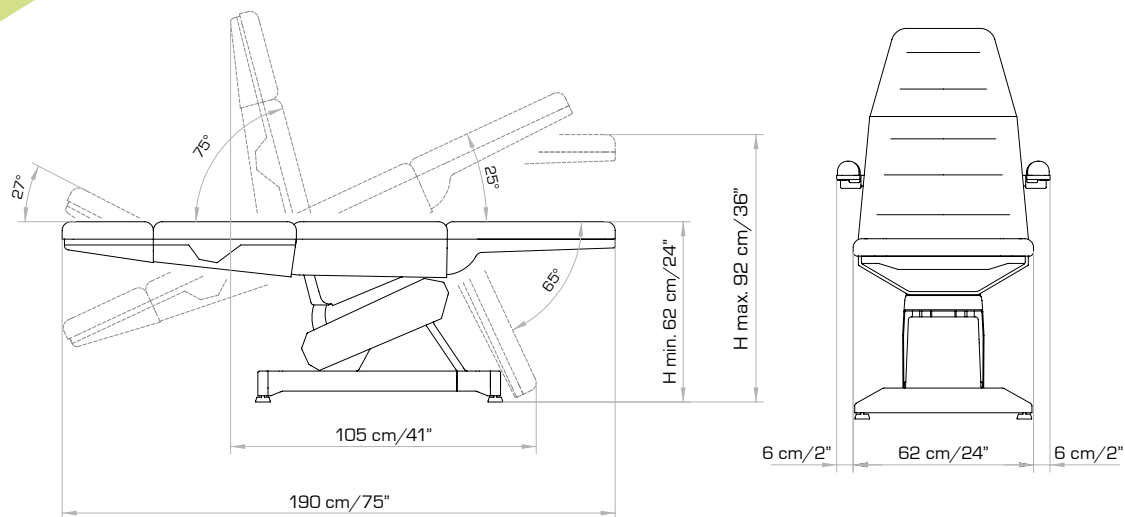

Lemi 4 is CE conformed and is manufactured in accordance with  
European Directives: 93/42/CE (class I); 2006/42/CE; 2004/108/CE;  
CEI EN 60204-1:2006-09; UNI EN 12100-1-2

*Lemi 4 è a norme CE ed è fabbricata in conformità alle seguenti Direttive Europee:  
93/42/CE (classe I); 2006/42/CE; 2004/108/CE;  
CEI EN 60204-1:2006-09; UNI EN 12100-1-2*

### Brusaferrì & C S.r.l.

Headquarters / *Sede operativa*: S.P. n. 6 • 26011 Casalbuttano (CR) • Italy  
Tel. +39 0374 363068/69 • Fax +39 0374 363071

[www.lemi.it](http://www.lemi.it) • [info@lemi.it](mailto:info@lemi.it)

### USA Branch:

Lemi USA LLC: 280 Fentress Blvd • Daytona Beach, FL. 32114  
T. 386-239-8433 • F. 386-239-8627

[www.lemiusa.com](http://www.lemiusa.com) • [info@lemiusa.com](mailto:info@lemiusa.com)



**Lemi**<sup>®</sup>  
MADE IN ITALY