

10%  
made in Italy

Medical Line

# DreaMed

Universal medicine  
*Medicina universale*



Multifunctional couch-bed  
*Poltrona-lettino multispecialistica*

**Lemi**<sup>®</sup>  
MADE IN ITALY

# Movements / Movimentazioni

ENT VISITS • DENTAL SURGERY AND IMPLANTOLOGY  
STOMATOLOGY • ORTHODONTICS • OPHTHALMOLOGY  
DIAGNOSTICS • MINOR SURGERY INTERVENTIONS

4 independent electric movements: height, back rest, leg rest, trendelenburg  
1 synchronized electric movement: back rest/leg rest  
2 manual movements: rotation and leg rest extension  
Automatic reset control to bring the couch back to the initial position

Electric height  
*Altezza elettrica*  
52-82 cm  
(20"-30")



Electric Trendelenburg  
*Trendelenburg elettrico*



90° rotation on both sides  
*Rotazione 90° da entrambi i lati*

VISITE DI OTORINOLARINGOIATRIA • CHIRURGIA DENTALE E IMPLANTOLOGIA  
STOMATOLOGIA • ORTODONZIA • OFTALMOLOGIA  
DIAGNOSTICA • PICCOLI INTERVENTI AMBULATORIALI

DreaMed • cod. 333

4 movimenti elettrici indipendenti: altezza, schiena, gambe, trendelenburg  
1 movimento elettrico sincronizzato: schiena/gambe  
2 movimenti manuali: rotazione ed estensione gambe  
Comando di azzeramento automatico che riporta il letto nella posizione base

Synchronized back rest/leg  
rest movement

*Movimentazione sincronizzata  
schiena/gambe*

Electric leg rest  
*Gambe elettriche*



Electric back rest  
*Schiena elettrica*



**3 motors version cod. 330**  
3 manual movements:  
rotation, leg rest inclination and extension

**Versione 3 motori cod. 330**  
3 movimenti manuali:  
rotazione, inclinazione ed estensione gambe

ENT VISITS • DENTAL SURGERY AND IMPLANTOLOGY  
STOMATOLOGY • ORTHODONTICS • OPHTHALMOLOGY  
DIAGNOSTICS • MINOR SURGERY INTERVENTIONS



Easy-to-clean anatomic  
mattress without stitching

*Materasso anatomico  
senza cuciture per una  
facile igienizzazione*

Its complete ABS covering  
grants elegance and safety  
while protecting the inner  
components from liquids

*Completamente chiuso con  
carter in ABS garantisce  
alla poltrona eleganza e  
sicurezza, proteggendo i  
componenti interni dai liquidi*

2 adjustable small feet  
under the base

*2 piedini regolabili  
alla base*

Wide choice of upholsteries  
available on stock

*Ampia scelta di rivestimenti  
disponibili a stock*

Maximum load weight  
without risk 200 kg

*Portata max in sicurezza  
200 kg*

Predisposition for medical  
accessories to adapt the  
couch to any purpose

*Predisposizione accessori  
medicali per adattare la  
poltrona ad ogni utilizzo*

4 electric actuators current  
continuous 24V cc

*4 motori elettrici 24V cc  
a regolazione continua*

Foot pedal control with  
automatic reset to zero

*Pedaliera con azzeramento  
automatico*



### Technical specifications

Minimum height: 52 cm - 20"  
Maximum height: 82 cm - 32"  
Angle of inclination trendelenburg: 30°  
Angle of inclination back rest: 80°  
Angle of inclination leg rest: 90°  
Mattress length: 168 cm - 66"  
Mattress length (with extended leg rest):  
185 cm - 73"  
Mattress width: 59 cm - 23"  
Rotation: 90° on both sides  
Latex-free, non-toxic and non-carcinogenic  
materials  
Fire-resistant upholstery: UNI 9175 class 1M

### Specifiche tecniche

Altezza minima: 52 cm  
Altezza massima: 82 cm  
Angolo inclinazione trendelenburg: 30°  
Angolo inclinazione schiena: 80°  
Angolo inclinazione gambe: 90°  
Lunghezza materasso: 168 cm  
Lunghezza materasso gambe estese:  
185 cm  
Larghezza materasso: 59 cm  
Rotazione: 90° su entrambe i lati  
Materiali privi di lattice, atossici e non  
cancerogeni  
Rivestimento ignifugo: UNI 9175 class 1M

### Electric requirements

Voltage: 230V ac, 110V ac  
Frequency: 50 Hz / 60 Hz  
Absorption: 0,70 A max  
Electric system conforms to CEI norms  
4 actuators 24V cc (thrust 6000 N)  
Class II control box 220Vac 50Hz  
Transformer 120 Va  
Class I medical device (dir. 93/42/CEE)  
Protection rating IP54  
Low-tension foot pedal control

### Packaging details

Size: 170x74x86h cm (67"x30"x34")  
Volume: 1,081 m<sup>3</sup>  
Gross weight: 92 kg - 203 lbs  
Net weight: 76 kg - 168 lbs

### Caratteristiche imballo

Dimensioni: 170x74x86h cm  
Volume: 1,081 m<sup>3</sup>  
Peso lordo: 92 kg  
Peso netto: 76 kg

### Caratteristiche elettriche

Voltaggio: 230V ac, 110V ac  
Frequenza: 50 Hz  
Assorbimento: 0,70 A max  
Impianto elettrico a norme CEI  
4 attuatori 24V cc (spinta 6000N)  
Centralina in classe II 220 Vac 50Hz  
Trasformatore da 120 Va  
Disp. Medico classe I (dir. 93/42/CEE)  
Grado di protezione IP54  
Pedaliera a bassa tensione

### Warranty

Structure: 10 years  
Motors and control: 2 years  
Cushion: 5 years

### Garanzia

Struttura: 10 anni  
Motori e comandi: 2 anni  
Imbottitura: 5 anni

Accessories upon request / Accessori su richiesta

The standard version includes flat armrests  
*La versione standard include i braccioli automatici*



cod. 108



cod. 316-317



cod. LEM-084



cod. GOP-012



cod. 331



cod. 314



cod. 318



cod. 313



cod. LEM-139



cod. 319-320



cod. LEM-151

**cod. 108**roll holder/*porta rotolo***cod. 316-317**seat and back rest medical guide couple  
*coppia guide medicali seduta e schiena***cod. LEM-084**hand set control / *pulsantiera***cod. GOP-012**lamp adaptor featuring a 60 mm  
diameter column  
*adattatore per supporto lampada  
completo di colonna ø60 mm***cod. 331**metal tray with support/*vassoio con supporto***cod. 314**blood-sample taking armrest  
*coppia braccioli da prelievo con snodo***cod. 318**jointed thigh support couple  
*coppia reggicoscie con snodo***cod. 313**medical armrest couple  
*coppia braccioli medicali***cod. LEM-139**wheels/*ruote***cod. 319-320**fixed and rotating clamp couple  
*coppia morsetti fissi girevoli***cod. LEM-151**heel support couple/*coppia reggi tallone***Mattress colors / Colori materasso****P35**

Bianco

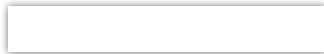
**B41**

Grigio

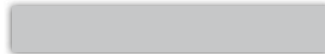
**B99**

Nero

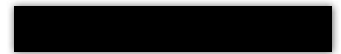
**D02**

Crema

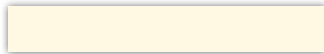
**G10**

Blu

**H98**

Viola

**G03**

Azzurro

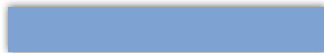
**EB1**

Verde

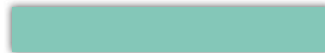
**E16**

Marrone

**G85**

Cielo

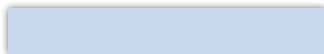
**N31**

Arancio

**Q73**

Mais

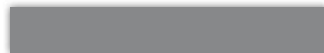
**ABS covering colors/ Colori carter****333 G**Light grey  
*Grigio***333 B**White  
*Bianco*

The colors above are provided only as a guide and could be subjected to a variation due to the material different from the printed paper.

*I colori sopra riportati sono indicativi e possono essere soggetti a variazioni dovute al materiale diverso dalla carta stampata.*

Product images are for illustrative purposes only.  
The manufacturer has the right to modify pictures and descriptions  
of this catalogue at any time for commercial or technical purposes.

*L'immagine ha il solo scopo illustrativo.  
Il costruttore si riserva il diritto di effettuare le modifiche  
alle immagini e alle descrizioni di questo catalogo  
in ogni momento per esigenze di carattere  
tecnico e commerciale.*

**credits:**

photo by Studio Pi-Tre



N° 443.090.V



## Table of dimensions / *Tabella dimensionale*

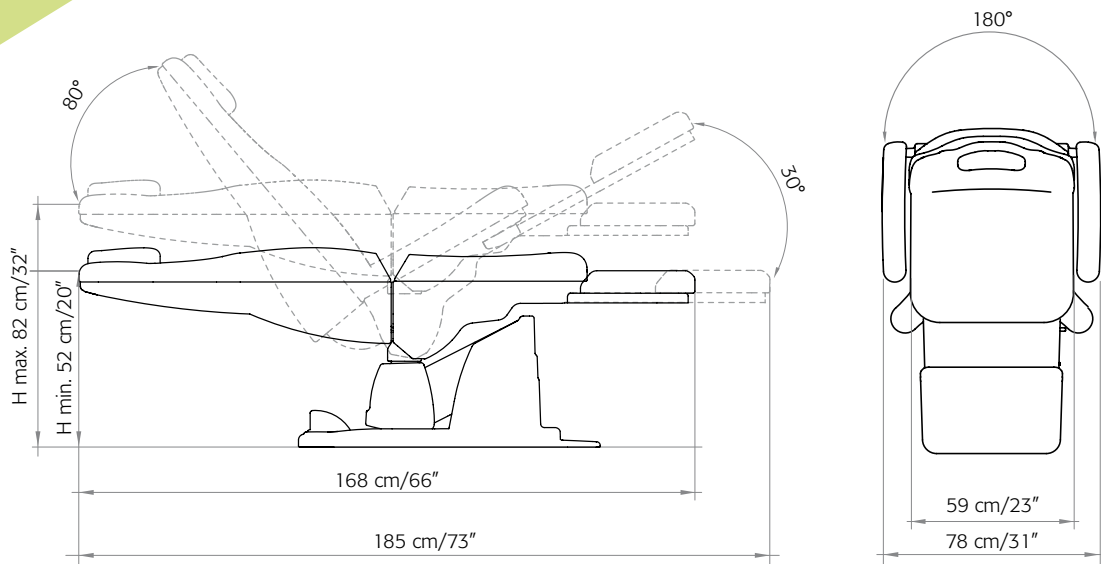

DreaMed is CE conformed and is manufactured in accordance with  
European Directives: 93/42/CE (class I); 2006/42/CE; 2004/108/CE;  
CEI EN 60204-1:2006-09; UNI EN 12100-1-2

*DreaMed è a norme CE ed è fabbricato in conformità alle seguenti Direttive  
Europee: 93/42/CE (classe I); 2006/42/CE; 2004/108/CE;  
CEI EN 60204-1:2006-09; UNI EN 12100-1-2*

### Brusaferrì & C S.r.l.

Headquarters / *Sede operativa*: S.P. n. 6 • 26011 Casalbuttano (CR) • Italy  
Tel. +39 0374 363068/69 • Fax +39 0374 363071

[www.lemi.it](http://www.lemi.it) • [info@lemi.it](mailto:info@lemi.it)

### USA Branch:

Lemi USA LLC: 280 Fentress Blvd • Daytona Beach, FL. 32114  
T. 386-239-8433 • F. 386-239-8627

[www.lemiusa.com](http://www.lemiusa.com) • [info@lemiusa.com](mailto:info@lemiusa.com)



**Lemi**<sup>®</sup>  
MADE IN ITALY